

KLT-SEG-OIS-FF-IMX258 V1.2

13MP Sony IMX258 OIS MGS MIPI Interface Fixed Focus Camera Module

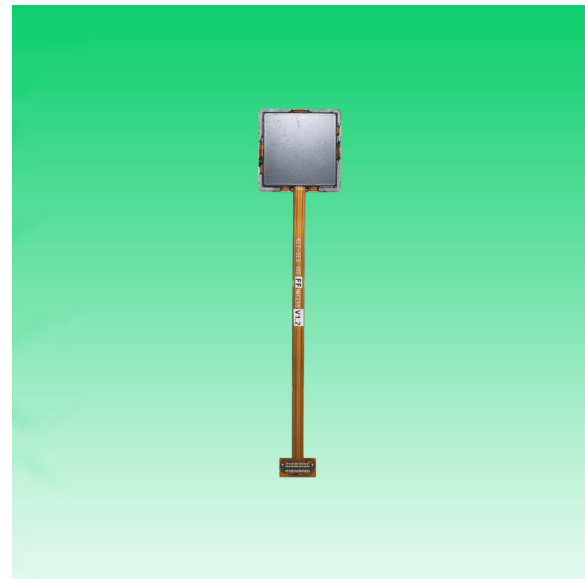

Camera Module No.	KLT-SEG-OIS-FF-IMX258 V1.2
Resolution	13MP
Image Sensor	IMX258 w/ MGS OIS
Sensor Type	1/3.06"
Pixel Size	1.12 um x 1.12 um
EFL	2.35 mm
F.NO	2.40
Stabilization Method	Optical Image Stabilization (OIS)
Stabilizer Type	Micro Gimbal Stabilizer (MGS)
Stabilizer Axis No.	2 Axis (Pitch and Yaw)
Stabilizer Angle	Max. 3.0°
Stabilizer Power	180 mW
Pixel	4224 x 3136
View Angle	127.0°(DFOV) 95.5°(HFOV) 70.0°(VFOV)
Lens Dimensions	19.0 x 19.0 x 9.90 mm
Module Size	89.00 x 19.00 mm
Module Type	Fixed Focus
Auto Focus VCM Driver IC	None
Interface	MIPI
Lens Type	650nm IR Cut
Operating Temperature	-20°C to +70°C
Mating Connector	BAF04-30083-0500

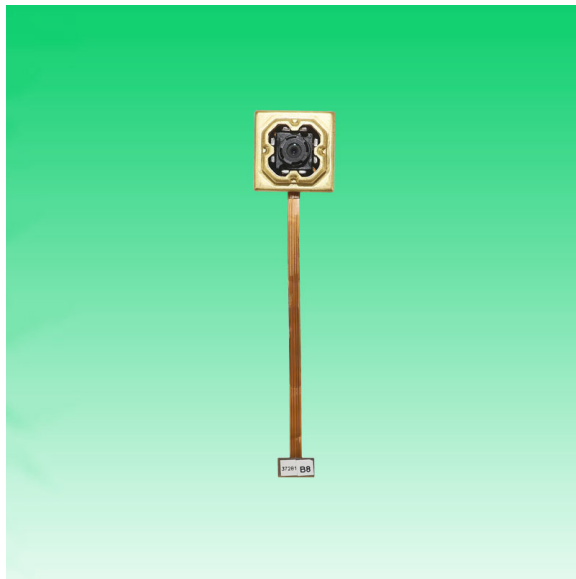

KLT-SEG-OIS-FF-IMX258 V1.2

13MP Sony IMX258 OIS MGS MIPI Interface Fixed Focus Camera Module



Top View

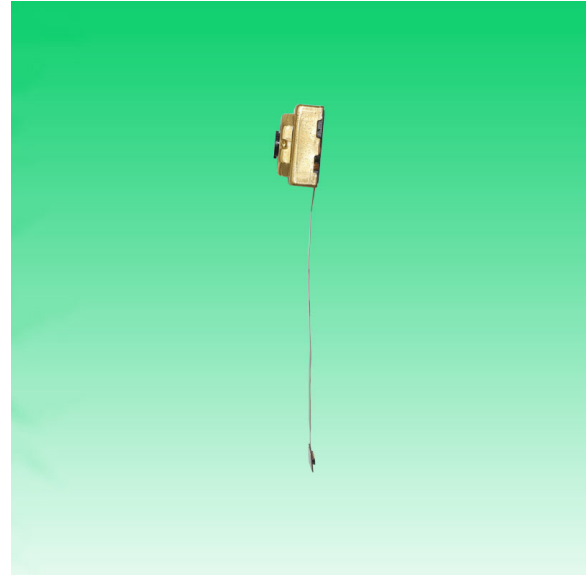

Side View



Bottom View



Mating Connector

RoHS

PIN	SIGNAL
1	VCM_GND
2	VCM_GND
3	VCM_3.3V
4	SDA
5	SCL
6	MIPI_GND
7	MCN
8	MCP
9	MDNO
10	MDPO
11	MDN1
12	MDP1
13	Tool0(NC)
14	MDN2
15	MDP2
16	MDN3
17	MDP3
18	AGND
19	AVDD_2.8V
20	VCM_3.3V
21	DGND
22	MCLK
23	DGND
24	/RST(NC)
25	PWDN(XCLR)
26	DVDD_1.2V
27	VDDIO_1.8V
28	Reset_N(GPIO)
29	ID(NC)
30	DGND

Version	Information	Date
V1.0	First Version	10-14-2020
V1.2	Change the cover	5-27-2021

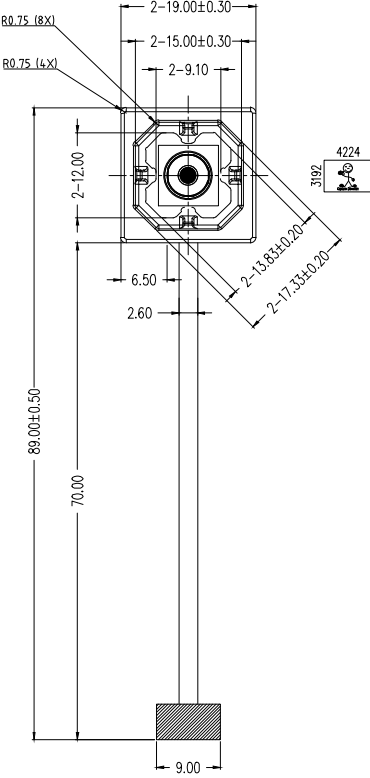

TOP VIEW

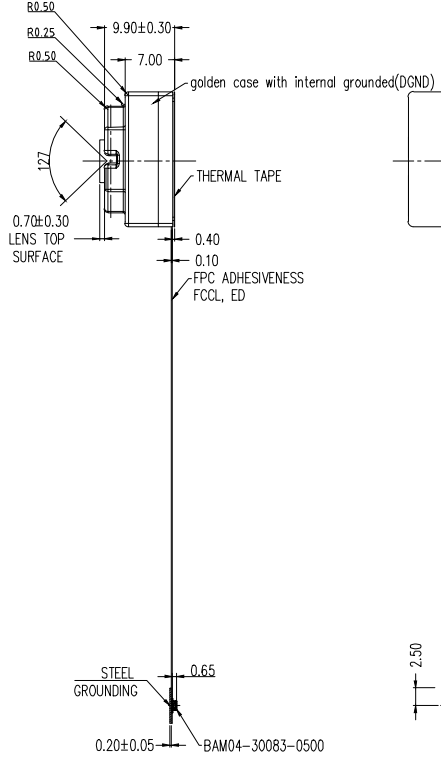

SIDE VIEW

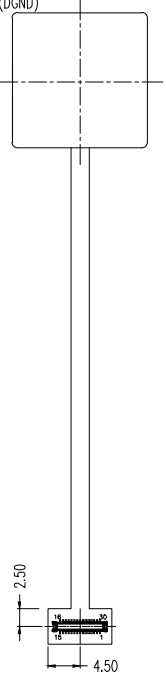

BOTTOM VIEW

Remark:

- Sensor I2C Slave Address: 0X34(W)/0X35(R)
- MGS Driver I2C Slave Address: 0X52(W)/0X53(R)
- VCM_3.3V: 3.3V(+/-0.05V) during operation
- AVDD_2.8V: 2.8V(+/-0.05V) during operation
- Reset_N : To control MGS on and off. When the pin pull high, MGS on. When the pin active low, MGS off.
- Tool0: NC, reserved

PARAMETERS PARAMETERS

Sensor Specification

Image Sensor: IMX258
 Pixel: 1.12umx1.12um
 Lens Type: 1/3.06"
 Important Voltage Description:
 VCM_3.3V: 3.3V
 AVDD_2.8V: 2.8V
 VDDIO_1.8V: 1.8V
 DVDD_1.2V: 1.2V

2、Lens specification:

FOV: 127°(D);99.5°(H);70°(V)
 F/NO.: 2.4
 TV distortion: <-10.5%
 Focal length: 2.35mm
 Composition: 6P+IR FILTER
 IR Cut Coating: 650nm±10nm@50%

Kai Lap Technologies Group Ltd

DESIGNED BY	Kevin	MODEL NAME	KLT-SEG-OIS-FF-IMX258 V1.2		
CHECKED BY	Aouly Yan	Projection Type:	Unit:	Material: -----	
		Third Angle	Scale: 1:1	Sheet: 1 of 1	Version: 1.0

[Product Brief]

Ver.1.0

IMX258

Diagonal 5.867 mm (Type 1/3.06) 13Mega-Pixel CMOS Image Sensor with Square Pixel for Color Cameras

Description

IMX258 is a diagonal 5.867mm (Type 1/3.06) 13 Mega-pixel CMOS active pixel type stacked image sensor with a square pixel array. It adopts Exmor RSM technology to achieve high speed image capturing by column parallel A/D converter circuits and high sensitivity and low noise image (comparing with conventional CMOS image sensor) through the backside illuminated imaging pixel structure. R, G, and B pigment primary color mosaic filter is employed. By introducing spatially multiplexed exposure technology, high dynamic range still pictures and movies are achievable. It

equips an electronic shutter with variable integration time. It operates with three power supply voltages: analog 2.7 V, digital 1.2 V and 1.8 V for input/output interface and achieves low power consumption.

In addition, this product is designed for use in cellular phone and tablet pc. When using this for another application, Sony does not guarantee the quality and reliability of product. Therefore, don't use this for applications other than cellular phone and tablet pc. Consult your Sony sales representative if you have any questions.

Functions and Features

- ◆ Back-illuminated and stacked CMOS image sensor Exmor RSM
- ◆ Phase Detection pixel data output for Phase Detection Auto Focus
- ◆ High Dynamic Range (HDR) mode with raw data output.
- ◆ High signal to noise ratio (SNR).
- ◆ Full resolution @30fps (Normal / HDR). 4K2K @30fps (Normal / HDR) 1080p @60fps (Normal)
- ◆ Output video format of RAW10/8.
- ◆ Pixel binning readout and V sub-sampling function.
- ◆ Independent flipping and mirroring.
- ◆ CSI-2 serial data output (MIPI 2lane/4lane, Max. 1.3Gbps/lane, D-PHY spec. ver. 1.1 compliant)
- ◆ 2-wire serial communication.
- ◆ Two PLLs for independent clock generation for pixel control and data output interface.
- ◆ Dynamic Defect Pixel Correction.
- ◆ Fast mode transition. (on the fly)
- ◆ Dual sensor synchronization operation.
- ◆ 4K bit of OTP ROM for users.
- ◆ Built-in temperature sensor.

Device Structure

- ◆ CMOS image sensor
- ◆ Image size : Diagonal 5.867 mm (Type 1/3.06)
- ◆ Total number of pixels : 4224 (H) × 3192 (V) approx. 13.48 M pixels
- ◆ Number of effective pixels : 4224 (H) × 3144 (V) approx. 13.28 M pixels
- ◆ Number of active pixels : 4208 (H) × 3120 (V) approx. 13.13 M pixels
- ◆ Chip size : 5.990 mm (H) × 3.908 mm (V)
- ◆ Unit cell size : 1.12 μm (H) × 1.12 μm (V)
- ◆ Substrate material : Silicon

System block diagram

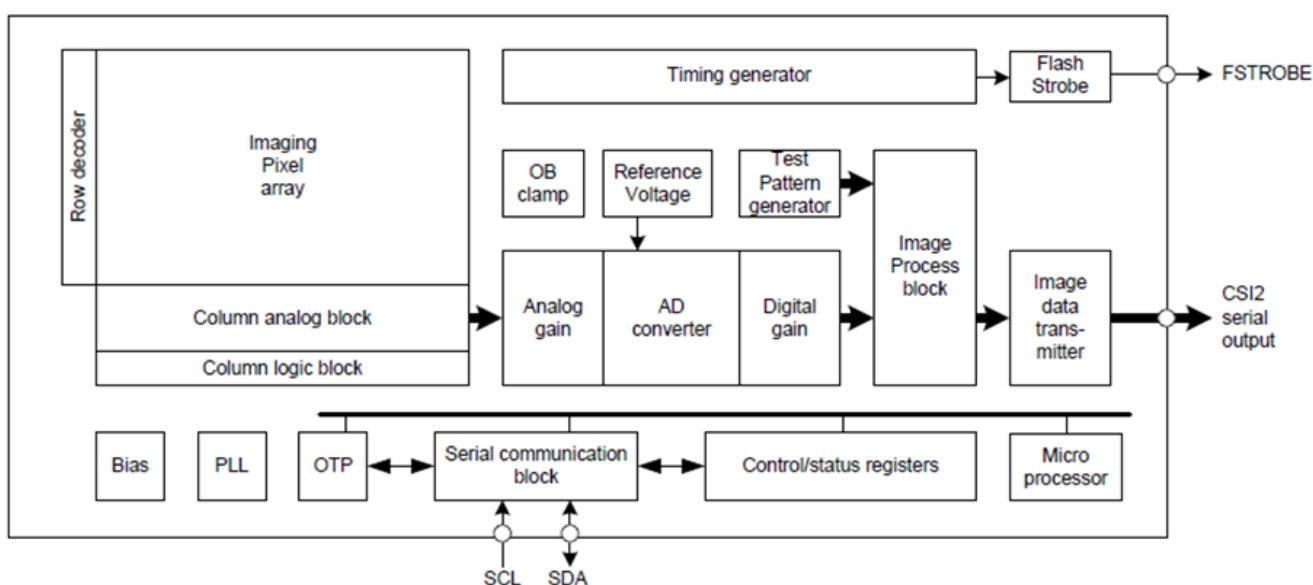

Exmor RS

* Exmor RS is a trademark of Sony Corporation. The Exmor RS is a Sony's CMOS image sensor with high-resolution, high-performance and compact size by replacing a supporting substrate in Exmor R™ which changed fundamental structure of Exmor™ pixel adopted column parallel A/D converter to back-illuminated type, with layered chips formed signal processing circuits.



Micro Gimbal Stabilizer (MGS) OIS Camera Modules

Micro Gimbal Stabilizer (MGS) is the patented mechanical optical image stabilizer (OIS) for camera modules. The MGS technology is tilting the image sensor and lens together, enabling anti-shaking performance for moving devices to take a sharp and clear image, even in the low light environment.



Features

2-Axis Compensation
Small, Light Weight
18.80x18.80x15.80mm



Smallest
Gimbal



Multi-Axis
Compensation

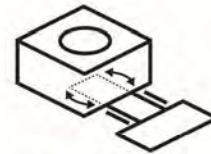

Embedded
Moving FPC



One-stop
Solution

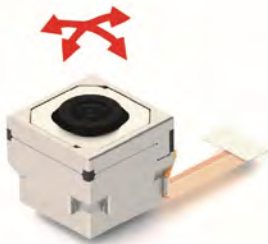

Stabilizer



Max. View Angle



Integrated
Design



Patents

Applications



**5G Smart
Helmet**



**Sport
Camera**



Drones



Robots



**Wearable
Cameras**



Micro Gimbal Stabilizer (MGS) for Mobile Phones

Micro Gimbal Stabilizer (MGS) is fitting in the compact size, enabling the smartphones and tablet PC to take clear images in the moving environment.

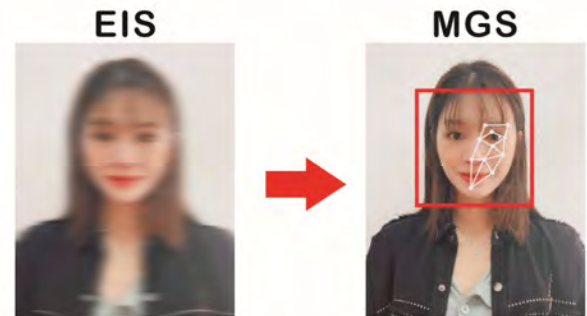
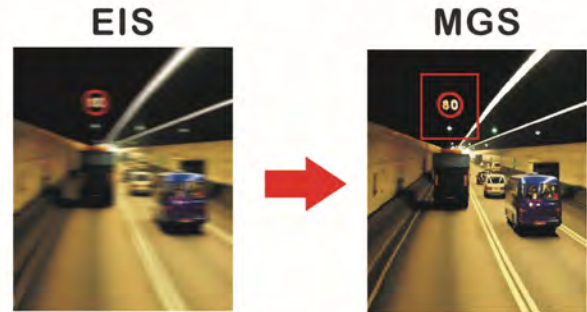
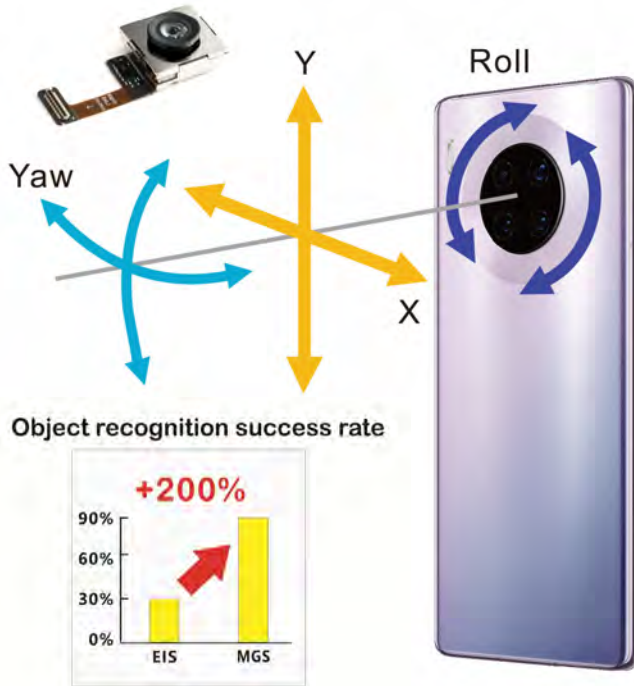



REV.	Q'TY	ECN. NO.	APR.	DATE
A	--	RC-12-2-019	Juson Su	2012.08.07

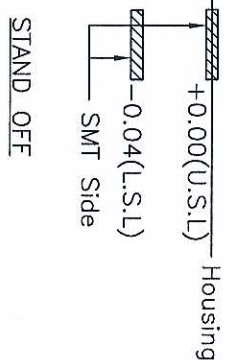
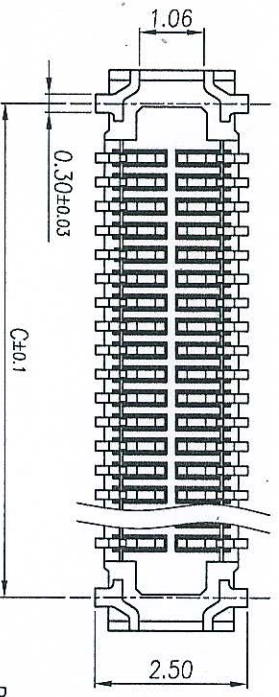
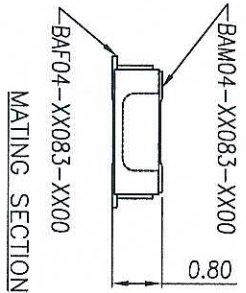
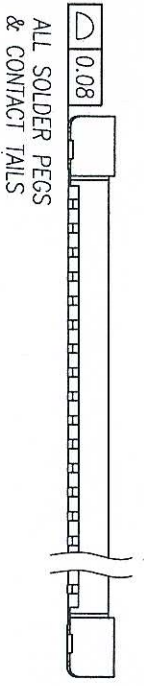
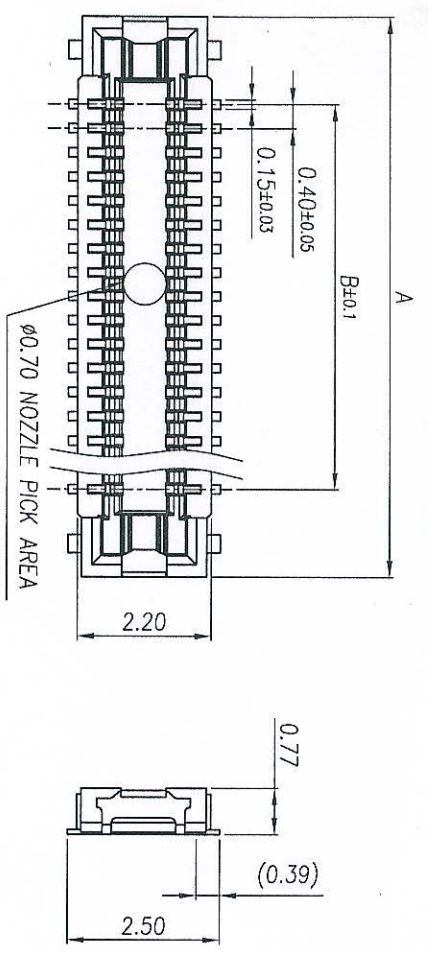
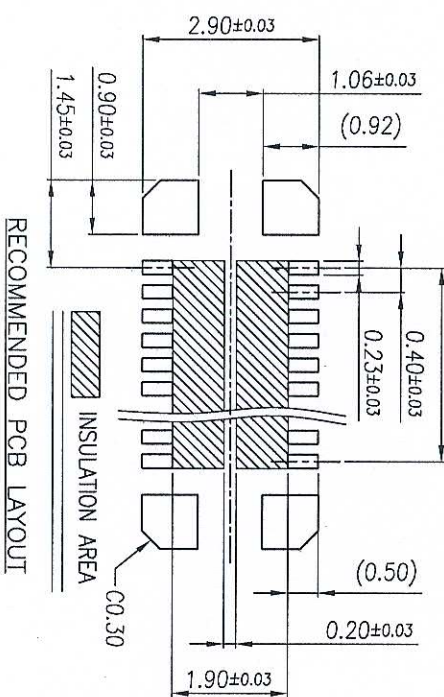
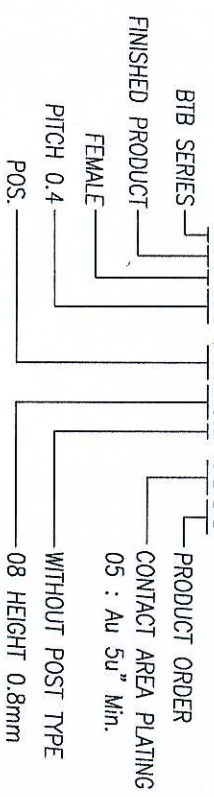

TABLE:

60	14.50	11.60	13.40	
50	12.50	9.60	11.40	
40	10.50	7.60	9.40	
34	9.30	6.40	8.20	
30	8.50	5.60	7.40	⊙
26	7.70	4.80	6.60	
24	7.30	4.40	6.20	⊙
20	6.50	3.60	5.40	
16	5.70	2.80	4.60	
10	4.50	1.60	3.40	⊙
Pos No:	A	B	C	Available



- NOTES:
- MATERIAL:
 - HOUSING: THERMOPLASTIC,U94 V-0,BLACK;
 - CONTACT: COPPER ALLOY, T=0.08mm
 - FINISH:
 - CONTACT: Au 5u" MIN PLATING ON CONTACT AREA, Au 1u" MIN. PLATING ON SOLDER TAIL, 50u" MIN. NICKEL UNDERPLATING OVER ALL
 - PRODUCT SPECIFICATIONS:
 - VOLTAGE RATING: 60V AC/DC
 - CURRENT RATING: 0.3A/CONTACT(MAX. 5A AT TOTAL CONTACT)
 - INSULATION RESISTANCE: 100MEG.OHM MIN(INITIAL)
 - WITHSTANDING VOLTAGE: 150V AC FOR 1 MINUTE
 - CONTACT RESISTANCE: 70 MILL.OHM MAX PER PIN INITIAL, AFTER CONDITION ΔR=20 MILL.OHM Max.
 - OPERATION TEMPERATURE: -55° TO +85°
 - MATING FORCE: 120g Max./POS.
 - UNMATING FORCE: 15g Min./POS.
 - DURABILITY: 30 CYCLES
 - PART NO: BAF04-XX083-0500



DIMENSION IN mm		TOLERANCE UNLESS OTHERWISE SPECIFIED	
X ± 0.35	X ± 5°	.XX ± 0.25	X ± 3°
.XXX ± 0.15	.XX ± 1°		

LCN Shenzhen Linkconn Electronics Co., Ltd.

APR: 0.4mm PITCH BTB FEMALE
CHK: MATING HEIGHT 0.8mm

DWG NO: BAF04-24083-0500

PROJ: CUSTOMER DRAWING
SCALE: N/A
SHEET: 1/2

DRG Kevin Wong 2012.08.07

REV. A

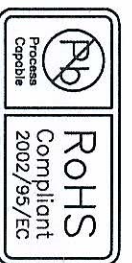

REV.	QTY	ECN. NO.	APR.	DATE
A	--	RC-12-2-019	Jason Su	2012.08.07

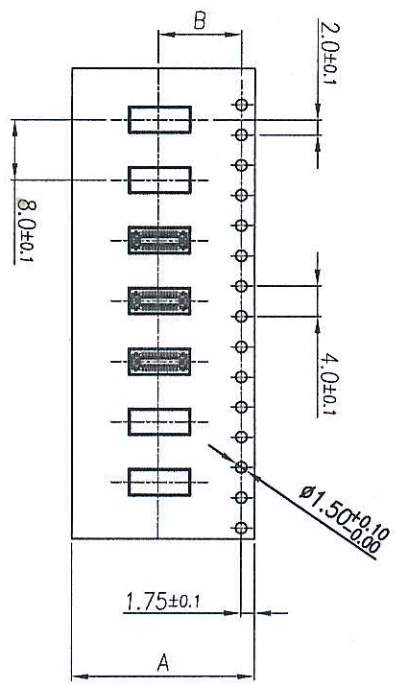
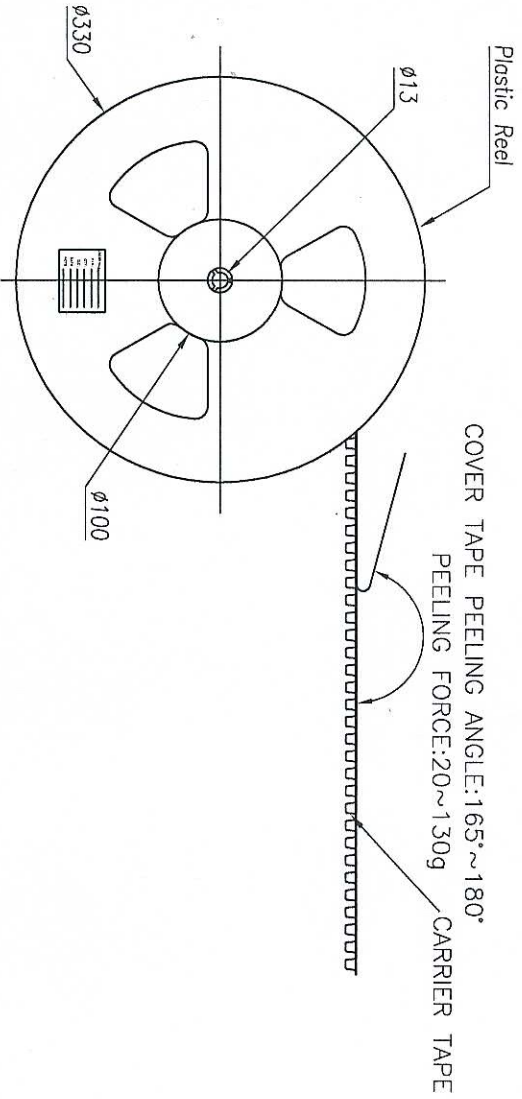
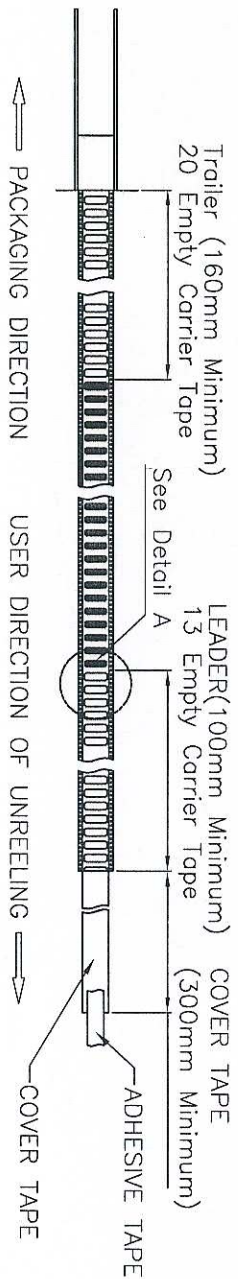

POS NO	DIM A	DIM B	QTY/REEL	REEL/CARTON	QTY/CARTON	CARTON SIZE
60						
50						
40	24.00	11.50	3000	10	30000	340*340*330
30						
26						
24						
20						
16	16.00	7.50	3000	14	42000	340*340*330
10						

DIMENSION IN mm		TOLERANCE UNLESS OTHERWISE SPECIFIED	
X ± 0.35	X ± 1.5'	APR	
.XX ± 0.25	.X ± 1.0'	CHK	
.XXX ± 0.15	.XX ± 0.5'	DR	Kevin Wang

LCW Shenzhen Linkcom Electronics Co., Ltd.

TITLE	0.4mm PITCH BTB FEMALE
DWG NO.	BAF04-24083-0500
PROJ.	CUSTOMER DRAWING
SCALE	N/A
SHEET	2/2
REV.	A



Cameras Applications



Automotive Driver Pilot



Live Streaming



Video Conference



Eye Tracker Biometric Detection

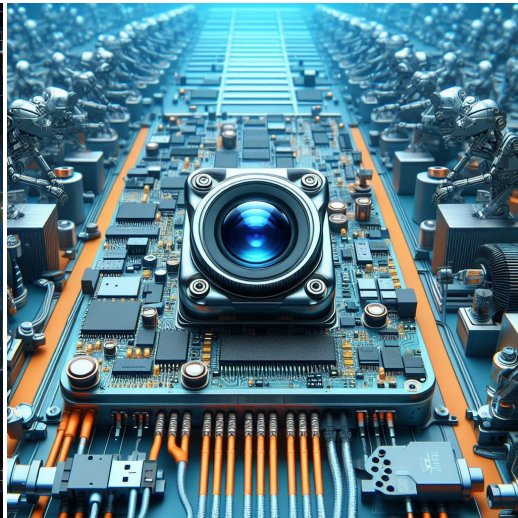

Machine Vision



Agricultural Monitor

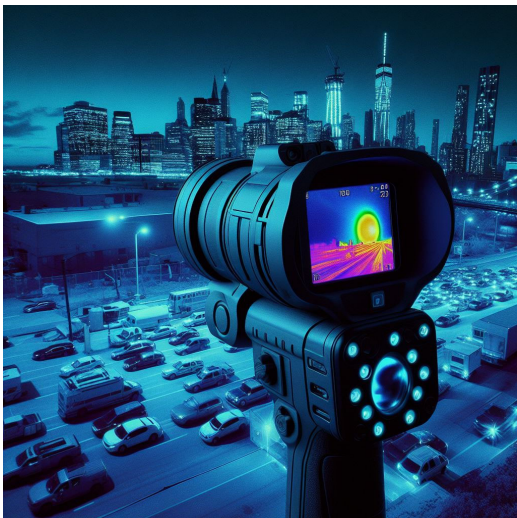

Night Vision Security



Drone and Sports Eagle Eyes



Interactive Pet Camera



your **BEST** camera module partner

Cameras Applications





Camera Module Pinout Definition Reference Chart

OmniVision	Sony	Samsung	On-Semi	Aptina	Himax	GalaxyCore	PixArt	SmartSens	Sensors
Pin Signal									
Description									
DGND	GND								
AGND									
PCLK	DCK								
XCLR	PWDN	XSHUTDOWN	STANDBY						
MCLK	XVCLK	XCLK	INCK						
RESET	RST								
NC	NULL								
SDA	SIO_D	SIOD							
SCL	SIO_C	SIOC							
VSYNC	XVS	FSYNC							
HREF	XHS								
DOVDD									
AFVDD									
AVDD									
DVDD									
STROBE	FSTROBE								
FSIN									
SID									
ILPWM									
FREX									
GPIO									
SLASEL									
AFEN									
MIPI Interface									
MDN0	DN0	MD0N	DATA_N	DMO1N					
MDP0	DP0	MD0P	DATA_P	DMO1P					
MDN1	DN1	MD1N	DATA2_N	DMO2N					
MDP1	DP1	MD1P	DATA2_P	DMO2P					
MDN2	DN2	MD2N	DATA3_N	DMO3N					
MDP2	DP2	MD2P	DATA3_P	DMO3P					
MDN3	DN3	MD3N	DATA4_N	DMO4N					
MDP3	DP3	MD3P	DATA4_P	DMO4P					
MCN	CLKN	CLK_N	DCKN						
MCP	CLKP	MCP	CLK_P	DCKN					
DVP Parallel Interface									
D0	DO0	Y0							
D1	DO1	Y1							
D2	DO2	Y2							
D3	DO3	Y3							
D4	DO4	Y4							
D5	DO5	Y5							
D6	DO6	Y6							
D7	DO7	Y7							
D8	DO8	Y8							
D9	DO9	Y9							
D10	DO10	Y10							
D11	DO11	Y11							



Camera Reliability Test

Reliability Inspection Item		Testing Method	Acceptance Criteria	
Category	Item			
Environmental	Storage Temperature	High 60°C 96 Hours	Temperature Chamber	No Abnormal Situation
		Low -20°C 96 Hours	Temperature Chamber	No Abnormal Situation
	Operation Temperature	High 60°C 24 Hours	Temperature Chamber	No Abnormal Situation
		Low -20°C 24 Hours	Temperature Chamber	No Abnormal Situation
	Humidity	60°C 80% 24 Hours	Temperature Chamber	No Abnormal Situation
	Thermal Shock	High 60°C 0.5 Hours Low -20°C 0.5 Hours Cycling in 24 Hours	Temperature Chamber	No Abnormal Situation
Physical	Drop Test (Free Falling)	Without Package 60cm	10 Times on Wood Floor	Electrically Functional
		With Package 60cm	10 Times on Wood Floor	Electrically Functional
	Vibration Test	50Hz X-Axis 2mm 30min	Vibration Table	Electrically Functional
		50Hz Y-Axis 2mm 30min	Vibration Table	Electrically Functional
		50Hz Z-Axis 2mm 30min	Vibration Table	Electrically Functional
	Cable Tensile Strength Test	Loading Weight 4 kg 60 Seconds Cycling in 24 Hours	Tensile Testing Machine	Electrically Functional
Electrical	ESD Test	Contact Discharge 2 KV	ESD Testing Machine	Electrically Functional
		Air Discharge 4 KV	ESD Testing Machine	Electrically Functional
	Aging Test	On/Off 30 Seconds Cycling in 24 Hours	Power Switch	Electrically Functional
	USB Connector	On/Off 250 Times	Plug and Unplug	Electrically Functional





Inspection Item		Inspection Method	Standard of Inspection		
Category	Item				
Appearance	FPC/ PCB	Color	The Naked Eye	Major Difference is Not Allowed.	
		Be Torn/Chopped	The Naked Eye	Copper Crack Exposure is Not Allowed.	
		Marking	The Naked Eye	Clear, Recognizable (Within 30cm Distance)	
	Holder	Scratches	The Naked Eye	The Inside Crack Exposure is Not Allowed	
		Gap	The Naked Eye	Meet the Height Standard	
		Screw	The Naked Eye	Make Sure Screws Are Presented (If Any)	
		Damage	The Naked Eye	The Inside Crack Exposure is Not Allowed	
	Lens	Scratch	The Naked Eye	No Effect On Resolution Standard	
		Contamination	The Naked Eye	No Effect On Resolution Standard	
		Oil Film	The Naked Eye	No Effect On Resolution Standard	
		Cover Tape	The Naked Eye	No Issue On Appearance.	
	Function	Image	No Communication	Test Board	Not Allowed
			Bright Pixel	Black Board	Not Allowed In the Image Center
Dark Pixel			White board	Not Allowed In the Image Center	
Blurry			The Naked Eye	Not Allowed	
No Image			The Naked Eye	Not Allowed	
Vertical Line			The Naked Eye	Not Allowed	
Horizontal Line			The Naked Eye	Not Allowed	
Light Leakage			The Naked Eye	Not Allowed	
Blinking Image			The Naked Eye	Not Allowed	
Bruise			Inspection Jig	Not Allowed	
Resolution			Chart	Follows Outgoing Inspection Chart Standard	
Color			The Naked Eye	No Issue	
Noise			The Naked Eye	Not Allowed	
Corner Dark			The Naked Eye	Less Than 100px By 100px	
Color Resolution			The Naked Eye	No Issue	
Dimension	Height	The Naked Eye	Follows Approval Data Sheet		
	Width	The Naked Eye	Follows Approval Data Sheet		
	Length	The Naked Eye	Follows Approval Data Sheet		
	Overall	The Naked Eye	Follows Approval Data Sheet		



KLT Package Solutions

KLT Camera Module



Complete with Lens Protection Film



Tray with Grid and Space



Place Cameras on the Tray





Camera Modules Package Solution

Full Tray of Cameras



Cover Tray with Lid



Put Tray into Anti-Static Bag



Vacuum the Anti-Static Bag

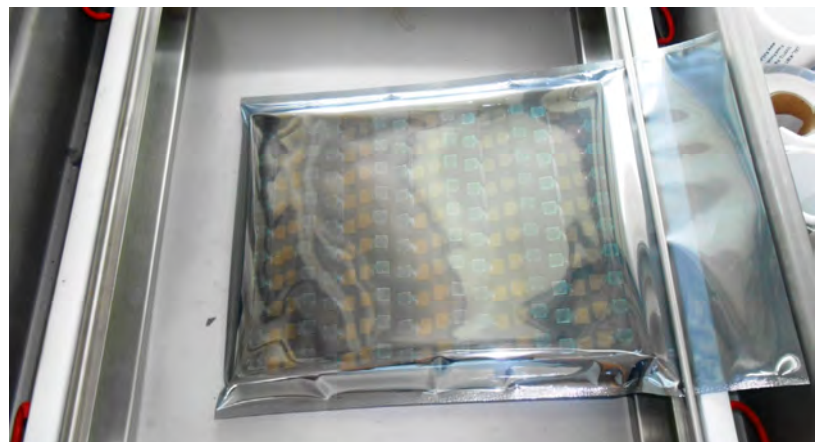



Camera Modules Package Solution

Sealed Vacuum Bag with Labels

1. Model and Description 2. Quantity 3. Shipping Date 4. Caution





Large Order Package Solution

Place Foam Sheets Between Trays



Foam Sheets are Slightly Larger than Trays



Place Foam Sheets and Trays into Box



Foam Sheets are Tightly Fitting Box





Small Order Package Solution

Place Foam Sheets and Trays into Small Box



Foam Sheets are Nicely Fitting the Small Box



Package in Small Box for Shipment



Place Small Boxes into Larger Box





your BEST camera module partner

Carbon Box Package Solution

Seal the Carbon Box

Final Package Labelled Box



Carbon Box Ready for Shipment

1. Delivery Address and Phone No. 2. Box No. and Ship Date 3. Fragile Caution





Sample Order Package Solution

Place Sample into Small Anti-Static Bag



Place Connectors into Small Ant-Static Bag



Sample Labels on the Small Bag

1. Camera Module or Connector Model 2. Shipping Date and Quantity 3. Caution





Connectors Large Order Package Solution

Connectors in a Wheel



Label Connectors in the Wheel



The Wheel is Perfectly Fitting the Box



Connectors Box Ready for Shipment





Company Kai Lap Technologies (KLT)

Kai Lap Technologies Group Limited. (KLT) was established in 2009, a next-generation technology driven manufacturer specialized in research, design, and produce of audio and video products. KLT is occupying 20,000 square feet automated plants with 100 employees of annual throughput 30,000,000 units cameras.

KLT provides OEM, ODM design, contract manufacturing, and builds the camera products. You may provide the requirements to us, even with a hand draft, our sales and engineering work together to meet your needs. We consider ourselves your last-term partner in developing practical and innovative solutions.

Our team covers everything from initial concept development to mass produced product. KLT specializes in customized camera design, raw material, electronic engineering, firmware/software development, product testing, and packing design. Our experienced strategic supply systems offer a robust and dependable manufacturing capacity for orders of various sizes.

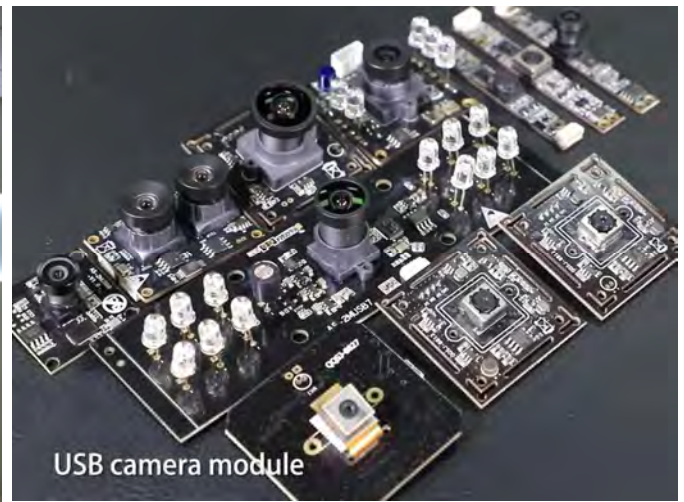

Limited Warranty

KLT provides the following limited warranty if you purchased the Product(s) directly from KLT company or from KLT's website, www.KaiLapTech.com. Product(s) purchased from other sellers or sources are not covered by this Limited Warranty. KLT guarantees that the Product(s) will be free from defects in materials and workmanship under normal use for a period of one (1) year from the date you receive the product ("Warranty Period").

For all Product(s) that contain or develop material defects in materials or workmanship during the Warranty Period, KLT will, at its sole option, either: (i) repair the Product(s); (ii) replace the Product(s) with a new or refurbished Product(s) (replacement Product(s) being of identical model or functional equivalent); or (iii) provide you a refund of the price you paid for the Product(s).

This Limited Warranty of KLT is solely limited to repair and/or replacement on the terms set forth above. KLT is not reliable or responsible for any subsequent events.





CMOS CAMERA MODULES



your BEST camera module partner

KLT Strength

Powerful Factory



Professional Service



Promised Delivery



www.KaiLapTech.com sales@KaiLapTech.com Tel: (852) 6908 1256 Fax: (852) 3017 6778

All rights reserved @ Kai Lap Technologies Group Ltd. Specifications subject to change without notice.